



Product Specification

Model: AT-LFP-12-100HV01

Version 1.0

Description: 12V 100Ah / 175A LiFePO₄ Metal Blade battery + Bracket Kit

4 January, 2022

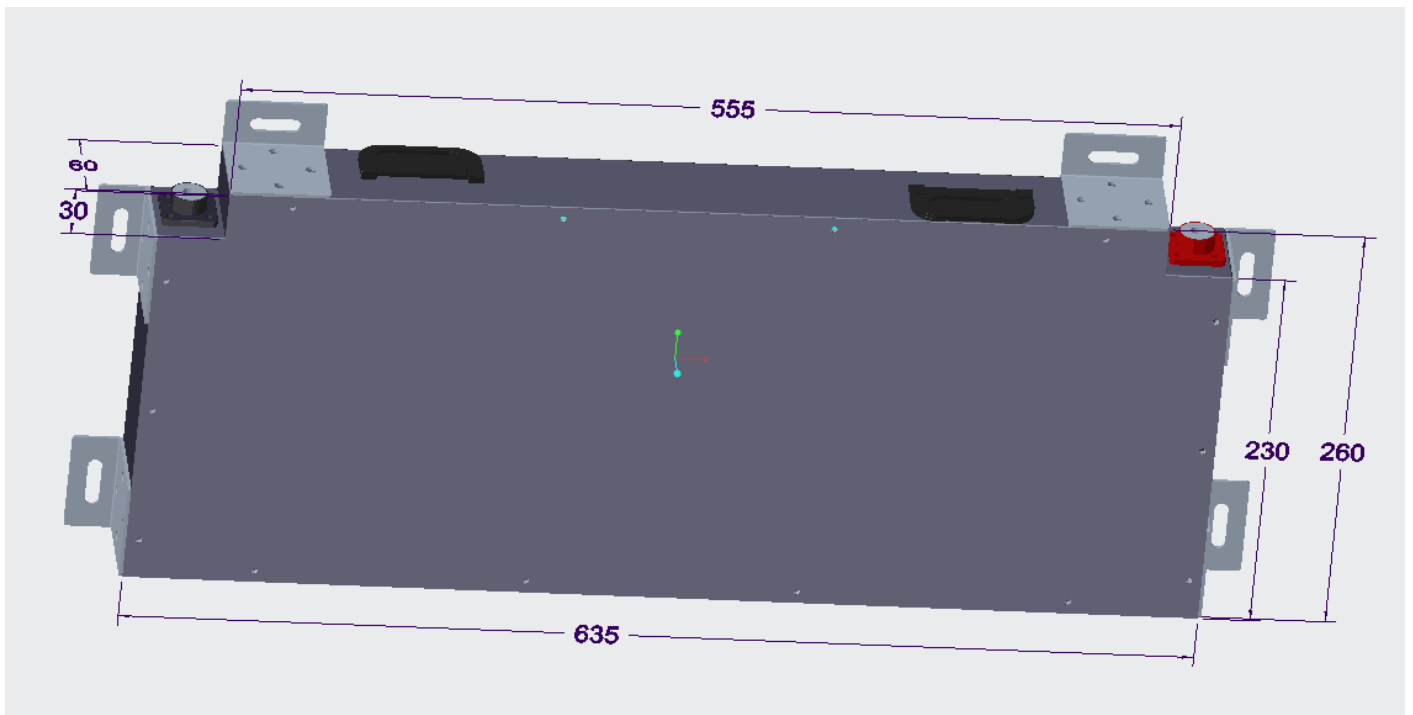

Introduction

AMPTRON® Portable Lithium Batteries are a **Plug and Play** replacement for any application currently using a deep cycle Gel, AGM or Flooded Lead Acid battery. Our Lithium batteries have an integrated Battery Protection System (BPS) and are designed to handle superior tolerances. The BPS maximizes the performance of the battery by automatically balancing the cells and protecting them from being over charged or over discharged. Our integrated BPS design is what allows our batteries to be used as an AR "Alternative Replacement" for any application requiring high quality, dependable and lightweight Lithium Batteries.

Heavy Duty - Built in Battery Protection System

AMPTRON® lithium batteries have a built-in Battery Protection System (BPS) designed to prevent damage to the cells from almost any external accidental occurrence that would normally cause damage. The internal Battery Protection System (BPS) will automatically disconnect to prevent damage to the cells if any cell drains too low. It will automatically reconnect when the charger is turned on. This protects the battery from over-discharging and damaging the cells. This technology also protects the battery from overcharge, short circuit and reverse polarity.

Internal Features:

- Low Voltage Protection Switch - Automatically disconnects around 10V
- Over Voltage Protection Switch - Automatically disconnects around 14.8V
- Short Circuit Protection Switch - Automatically disconnects
- Reverse Polarity Protection Switch - Automatically disconnects
- Internal cell balancing - Automatically balances cells.
- Charge Balancing - Independent balancing for multiple batteries connected in parallel or in series.

This Battery Protection System is designed to last throughout the life of the battery and provide reliable power for thousands of cycles.

CELL BALANCING

The BMS balances the cells by sending more current through the length way circuit boards and into cells with a lower voltage. The BMS will also discharge cells that exceed 3.65V during charging.

THERMAL FUSE

Internal Cell Safety Fuse

Our latest cell technology is manufactured with an internal thermal safety fuse between the anode and cathode that will break and disconnect in the unlikely event the cell would begin to overheat.

SAFETY VENT

High pressure safety vent

Each cell has a high-pressure safety vent that will flip open to release energy and prevent explosion.

ELECTROLYTE

Flame Retardant Electrolyte

Our cells are manufactured with our patented flame-retardant additive in our electrolyte.

Cells

The cells are the heart of a Lithium battery. The battery pack uses our very high-quality A-grade prismatic cells that has a high discharge current rating and excellent cycle life performance. These cells are capable of producing a continuous discharge current of 3C (300% of its rated capacity in Amps) and a huge peak discharge of 5 C (500% of its rated capacity in Amps) for 10 seconds.

Ampron prismatic cells



Data Sheet

Item	Specification	Description/Remark
Model	AT-LFP-12-100HV01	12V 100Ah / 175A LiFePO ₄ Metal Blade battery + Bracket Kit
Chemistry	Lithium Iron Phosphate (LiFePO ₄)	
Battery dimensions	635mm x 60mm x 260mm	L x W x H
Weight	About 15kg	
Cell type	3.2V 50Ah Prismatic cells	
Battery module	8 pcs 3.2V 50Ah cells, 4 serial and 2 parallel	4S2P
Standard capacity (0.2C5A)	100Ah / 1280Wh	
Cycle life	2000 cycles @ 100% DoD	Capacity ≥ Standard capacity x 80% Test conditions at 25°C, 1C / 1C charge and discharge rate. Higher cycle life can be achieved at lesser charge and discharge rates.
Rated voltage	12.8V	Working voltage per cell: 3.2V
Max. charge voltage	14.6V	Maximum charge voltage per cell: 3.65V
Cut-off voltage	Around 10V	2.5V single average cell voltage
Depth of Discharge (DoD)	100%	Batteries can be discharged to 100% of the rated capacity.
Standard charge current	20A	0.2C
Charging time	About 5 hours	When charging from low voltage cut-off point
Max continuous discharge current	175A	1.75C
Peak discharge current	320A	3.2C (5 seconds)
Charge /discharge efficiency	≥96%	
Operating temperatures	Charge 0°C~45°C Discharge -20°C~60°C Storage -20°C~45°C	
Impedance (Max, at 1000Hz.)	≤ 5mΩ	
Storage performance	Capacity can be kept ≥ 80% in storage for 12months	Battery should be kept at -20°C ~ 45°C where it's dry, clean, and well-ventilated.

So Why Consider Changing to Lithium Technology

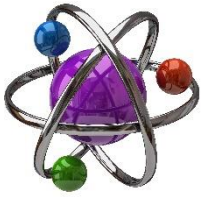

Super Energy Density, more usable energy in less space



Lighter, more compact & portable



Longer life-cycle & cost efficient



Environmentally friendly & more energy efficient



Built to service higher loads



Delivers stable Voltage



Faster to charge

Some Frequently Asked Questions

Q> Are Lithium batteries safe?

Lithium Iron Phosphate (LiFePO₄) batteries are the safest type of Lithium batteries as they will not overheat, and even if punctured they will not catch on fire. The cathode material in LiFePO₄ batteries is not hazardous, and so poses no negative health hazards or environmental hazards. Due to the oxygen being bonded tightly to the molecule, there is no danger of the battery erupting into flames like there is with Lithium-Ion. The chemistry is so stable that LiFePO₄ batteries will accept a charge from a Lead Acid configured charger.

Q> Can I use AMPTRON® LiFePO₄ batteries as a replacement for Lead Acid batteries?

AMPTRON® Lithium LiFePO₄ batteries are a Plug and Play replacement for any application currently using deep cycle Gel, AGM or Flooded Lead Acid batteries.

Q> What is the life expectancy of a Lithium battery?

The typical estimated life of the AMPTRON® Lithium Iron Phosphate (LiFePO₄) battery is 5-15 years, or 2000 to 5000 charge cycles.

Q> Do Lithium batteries have a memory?

Unlike NiCad batteries, Lithium LiFePO₄ batteries do not have a charge memory. That means carefully controlled deep-discharge cycles are not required, and partial-discharge cycles has no negative effect on the batteries.

Q> Why are Lithium Iron Phosphate LiFePO₄ batteries better?



LiFePO₄ (also known as Lithium Iron Phosphate) batteries are a huge improvement over Lead Acid batteries in weight, capacity and life cycles. The LiFePO₄ batteries are the safest type of Lithium batteries as they will not overheat, and even if punctured they will not catch on fire. The stability of the chemistry also gives these batteries exceptionally long life.

Q> When should I charge my Lithium battery?

Lithium Iron Phosphate (LiFePO₄) batteries can be left or cycled in a partially discharged state for long periods with few or no adverse effects, such as sulphation. AMPTRON® lithium batteries have a built-in Battery Protection System (BPS), that will automatically disconnect when the low voltage cut-off is reached, protecting the batteries from excessive discharge. These batteries also do not have a charge memory. All of this means that the batteries can be charged at any point. However, to maximize the battery life, it is recommended to recharge the batteries when they reach 20% State of Charge or higher.

Comparison with deep cycle Lead Acid (Flooded, AGM, Gel) batteries

The table below summarises the comparisons between AMPTRON®'s Lithium Iron Phosphate (LiFePO₄) batteries vs. Lead Acid batteries:

Category	AMPTRON® LiFePO ₄ batteries	Lead Acid (Flooded, AGM, Gel) batteries
Cycle life	<p>2000-5000</p>  <p>Lithium</p>	<p>400-800</p>  <p>Lead acid</p>
	<p>The expected lifespan of an Amptron LiFePO₄ battery is 4 to 10 times the lifespan of Lead Acid batteries.</p>	
	<p>Expected life of >2000 at regular 100% Depth of Discharge (DoD), and up to 5000 cycles at 80% DoD. The typical estimated life of the AMPTRON® Lithium Iron Phosphate (LiFePO₄) battery is 7-15 years, or 2000 to 5000 charge cycles</p>	<p>Well looked-after AGM batteries might have a life of 400 to 800 cycles at 50% Depth of Discharge (DoD). Other lead Acid battery types are generally less.</p>

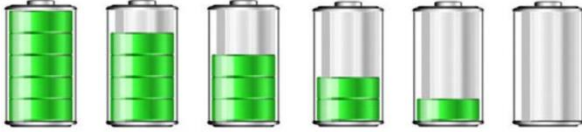
Category	AMPTRON® LiFePO ₄ batteries	Lead Acid (Flooded, AGM, Gel) batteries
Depth of Discharge (DoD)	<p>Battery is full</p>  <p>Depth of discharge: 0% 20% 40% 60% 80% 100%</p>	
	<p>An Amptron LiFePO₄ battery will typically provide twice the usable energy than a deep cycle Lead Acid battery of the same rated capacity.</p>	
	<p>You can safely go down to 100% DoD of the rated capacity and still expect >2000 cycles. 100Ah of rated capacity yields the full 100Ah useable capacity – at least 2 times the useable capacity of an AGM.</p>	<p>It is generally accepted that the most economic and practical DoD for an AGM battery is 50% (the "50%" rule). Other lead Acid battery types have an even lesser practical DoD. 100Ah of AGM gives you 50Ah useable under the 50% discharge rule – at most 50% of the</p>

		usable capacity of the 100Ah AMPTRON® LiFePO ₄ battery.
--	--	--

Category	AMPTRON® LiFePO ₄ batteries	Lead Acid (Flooded, AGM, Gel) batteries
Weight		
	An Amtron LiFePO ₄ battery provides 4 times the usable energy than a Lead Acid battery of the same weight.	
	Usable amp-hour for amp-hour, is about 1/4 the weight of lead-Acid batteries. This ratio reduces further under heavy loads.	Usable amp-hour for amp-hour, is about 4 x the weight. This ratio increases further under heavy loads.

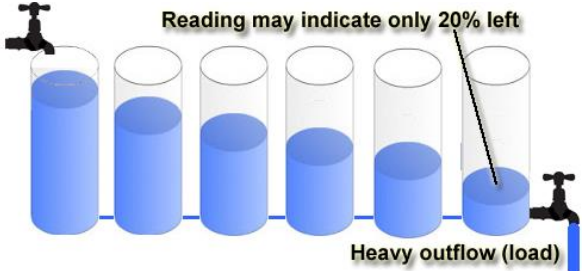
Category	AMPTRON® LiFePO ₄ batteries	Lead Acid (Flooded, AGM, Gel) batteries
Voltage Drop		
	Constant heavy loads do not significantly impact the voltage of Amtron LiFePO ₄ batteries, whereas the voltage of Lead Acid batteries significantly drops.	
	Minimal voltage drop under load. If a battery is at 13.3 volts and you pull a high current out of it, the voltage will still retain 13.3 volts	Voltage drops significantly under load. Impacts are that lights can dim, appliance start cycles may get interrupted due to a voltage drop, or appliances may run inefficiently.

	while delivering the current demand.	
Category	AMPTRON® LiFePO ₄ batteries	Lead Acid (Flooded, AGM, Gel) batteries
Peukerts effect (The impact of current on the usable amp-hours)	<p style="text-align: center;">Peukert Curve</p> <p>The graph shows two curves: a solid red line for 'Intermittent discharge' and a dashed red line for 'Continuous discharge'. Both curves show that as discharge time increases, the effective cell capacity also increases. The y-axis is labeled 'Discharge Current' and the x-axis is 'Discharge Time' (1-13 hours). A blue curve shows the relationship between current and time, indicating that higher currents result in shorter discharge times.</p>	
	Under heavy loads, the usable capacity of a Lead Acid battery is diminished, whereas the effect on the Amptron LiFePO ₄ battery is negligible.	
	The AMPTRON® LiFePO ₄ battery has a negligible effect in normal use.	The higher the current the fewer the amp-hours the battery will deliver. This effect progressively deteriorates as the battery ages. For example, a Lead Acid battery with a C20 capacity of 100Ah, will deliver 5 amps for 20 hours (5h x 20A = 100Ah). However, it will not deliver 50 amps for 2 hours (50A x 2h = 100Ah) or 100 amps for one hour. In effect, the higher current reduces the usable amp hours.

Category	AMPTRON® LiFePO ₄ batteries	Lead Acid (Flooded, AGM, Gel) batteries
Discharge Curve	<p>The left graph shows the discharge curve for AMPTRON LiFePO₄ batteries at 0.5C (black line) and 0.2C (red line). The voltage remains very flat, around 3.2V, until approximately 100Ah, then drops sharply. The right graph shows the discharge curve for Lead Acid batteries at 1C, 3h(0.6C), 3h(0.2C), and 5h(0.2C). The voltage drops significantly as discharge time decreases, starting from 2.0V and falling to 1.4V.</p>	
	For most of its discharge, even under heavy loads, the voltage of Amptron LiFePO ₄ batteries remain close to maximum, whereas the voltage of Lead Acid batteries significantly and quickly drops.	
	Very flat discharge curve, this means that LifePO ₄ batteries can hold its voltage near maximum during discharge at above 12.8V,	Drops voltage significantly as the battery discharges. This may cause some appliances to pull a higher current, in an effort to compensate, run slow, have

	until the battery reaches about 95% DoD.	lack of power, may not work effectively or even stop functioning early before the usable energy is consumed.
--	--	--

Category	AMPTRON® LiFePO ₄ batteries	Lead Acid (Flooded, AGM, Gel) batteries
Charge time and charge rate		
	Ampron LiFePO ₄ batteries charge much faster than Lead Acid batteries.	
	<ol style="list-style-type: none"> 1. Tolerates a higher bulk charge rate than most deep-cycle Lead Acid batteries. The recommended charge rate for maximum cycle life is 0.5C i.e. 50A for a 100Ah battery, but can be charged up to 1C i.e. 100A for a 100Ah battery. 2. Can consume full charge until the batteries get to 14.6 volts, followed by about 20 minutes at that voltage for cell balancing (not capacity) and then float. Batteries are fully charged up to four hours earlier compared to Lead Acid batteries 	<ol style="list-style-type: none"> 1. The recommended charge rate for large size AGM batteries is 0.2C, i.e. 20A for a 100Ah battery. Higher charge rates will heat up the battery and due to internal resistance, the absorption voltage will be reached when the battery is charged at only 60% or less, this resulting in a longer absorption time required to fully charge the battery. High rate charging will therefore not substantially reduce the charging time of a Lead Acid technology battery. 2. Typically needs some hours at a constant voltage with tapering current to charge the last 20% (40% of usable capacity).

Category	AMPTRON® LiFePO ₄ batteries	Lead Acid (Flooded, AGM, Gel) batteries
Charge Efficiency		
	Amprtron LiFePO ₄ batteries use less energy to fully charge than Lead Acid batteries of the same rated capacity.	
	Higher charge efficiency (>95%). That means to get 100Ah into the battery it might only require about 105Ah or less. This means less wastage of valuable solar energy, less generator run-time, and quicker time-to-full charge.	Lower charge efficiency (<75%). That means to get 100Ah into the battery will require >125Ah of charge.

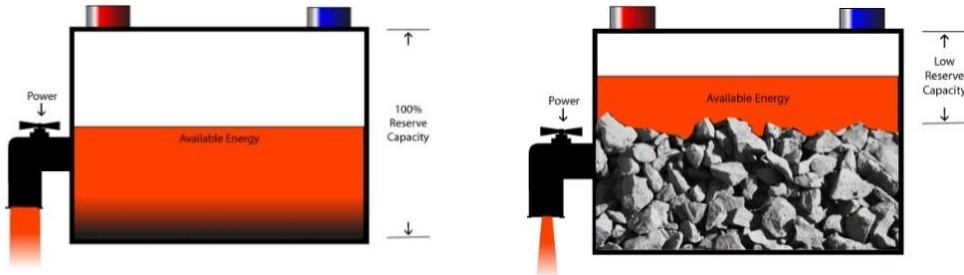
Category	AMPTRON® LiFePO ₄ batteries	Lead acid (Flooded, AGM, Gel) batteries
Storage Performance		
	Amprtron LiFePO ₄ batteries can be stored for much longer periods and at a lower charged state than Lead Acid batteries	
	Can be left or cycled in a partially discharged state for long periods with few or no adverse effects, such as sulphation.	Needs to be stored in a fully charged state and needs to be recharged regularly, or sulphation starts to occur which significantly impacts the cycle life.